

# a

by arturo alvarez

luisa collection

LED

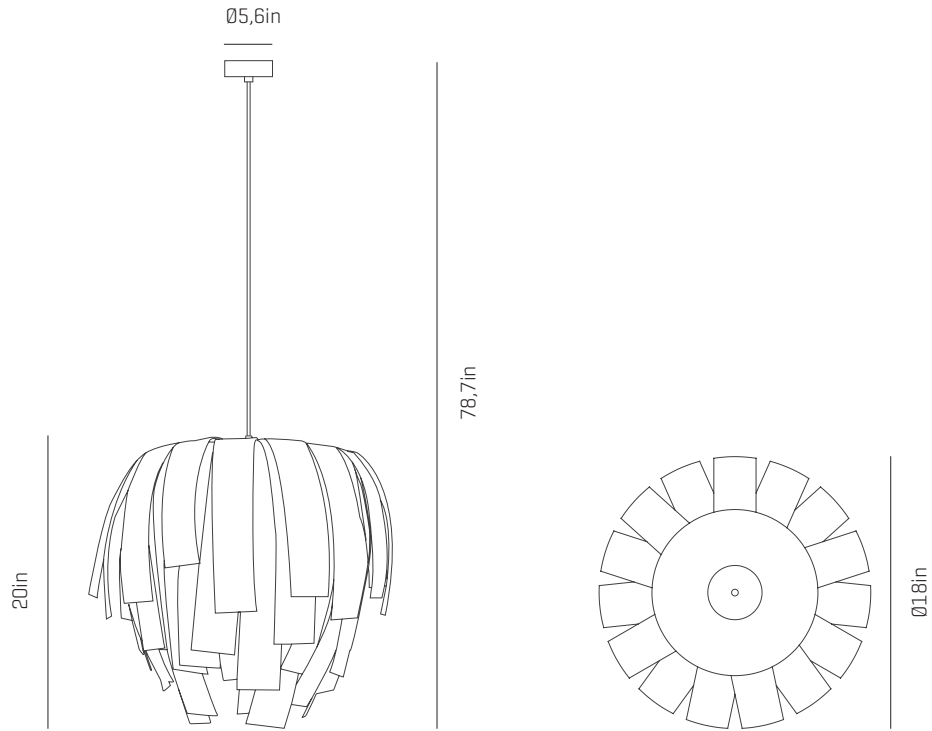

USA & Canada

ref. LS04G-LD



## MATERIALS & COMPONENTS

### LAMPSHADE

Painted stainless steel | One color to choose

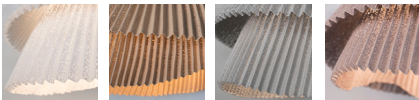

BL

BE

G

T

CUSTOM  
COLOR

Stainless steel

Bottom diffuser

### CANOPY AND CABLE

Steel gloss nickel-plated

Transparent

Standard: 78,7in

Length customizable

### LIGHT SOURCE BUILT IN

#### 100~277V - 60Hz

18,1W 3000K 1776lm built-in  
upon request 2700K 1645lm

Dimming system: 0-10V  
upon request PHASE CONTROL (only 120V)

## OTHER DATA

### NET WEIGHT

7,3lb

### PACKAGING

20x 20x 20,9in

10,1lb

### ELECTRICAL FEATURES



### CERTIFICATIONS



## Luisa

ref. **LS04G-LD**

Suitable for indoor use, at 77°F

Convient pour une utilisation en intérieur à une température ambiante de 77°F

Apta para uso interior a temperatura ambiente de 77°F

Box contains | Contenu de la boîte | Contenido de la caja:

- A** - Lampshade | Abat jour | Tulipa [1]
- B** - Holding piece | Pièce de fixation | Pieza de sujeción [1]
- C** - Security screws | Vis de sécurité | Tornillos de seguridad [2]
- D** - Wall Plugs | Chevilles | Tacos [2]
- E** - Canopy | Rosace | Florón [1]
- F** - Screws | Vis | Tornillos [2]

LED

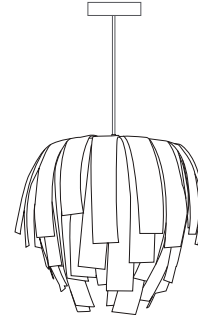

**SAFETY NOTE:** Switch off mains supply before commencing installation

**INFORMATION DE SÉCURITÉ:** Debranchez l'alimentation avant de commencer l'installation

**INDICACIÓN DE SEGURIDAD :** Desconecte la alimentación eléctrica antes de empezar la instalación

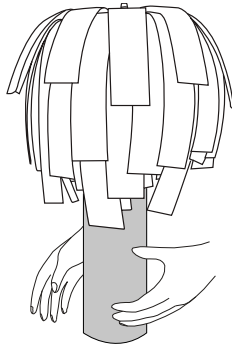

**ATTENTION!** During installation, handle the lampshade by the cardboard-die, prevent the possibility of modify its original design.

**ATTENTION!** Pendant l'installation, manipulez la luminaire avec la matrice en carton de sorte que le design originale ne peut pas être modifiée.

**¡ATENCIÓN!** Durante la instalación, manipular la luminaria por el troquel de cartón, evitando que se pueda modificar su diseño original.

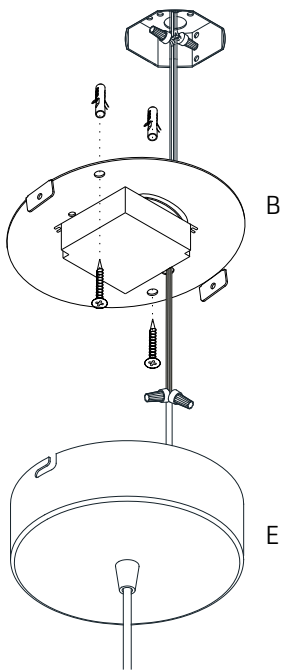

100-277V  
50/60 Hz

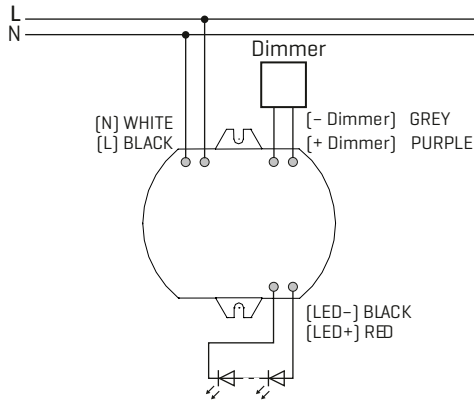

AC INPUT: main supply		DC OUTPUT: LED		Dimming control	
N	L	-	+	-	+
white	black	black	red	grey	purple

## 1

1.1 Drill the holes in the ceiling, fit the wall plugs into them and screw the holding piece.  
1.2 Switch off the main electrical supply and do the electric connection, please follow the instructions.

1.1 Faites les trous dans le plafond, placez les chevilles et vissez la pièce de serrage.  
1.2 Débranchez l'alimentation principale et effectuez le raccordement électrique en suivant les instructions.

1.1 Realizar los agujeros en el techo, colocar los tacos y atornillar la pieza de sujeción.  
1.2 Desconectar la corriente principal y hacer la conexión eléctrica siguiendo las instrucciones.

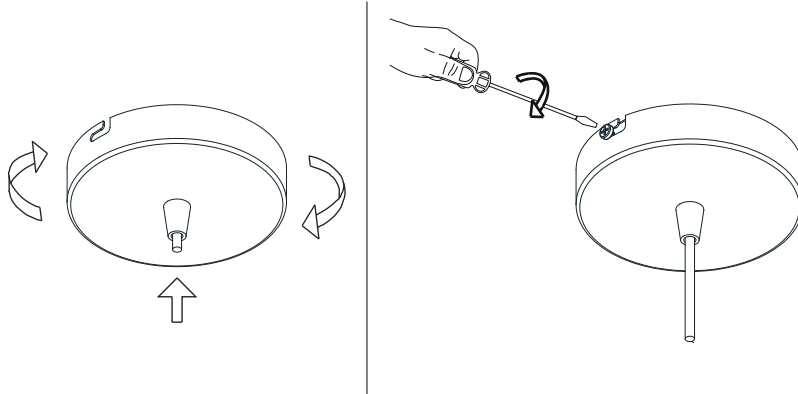

## 2

Insert the canopy in the holding piece and tight the security screws.  
Tighten the strain relief situated on the canopy

Insérez la rosace de plafond dans la pièce de fixation et serrez les vis de sécurité.  
Serrer le serre-câble situé sur la canopée

Encajar el florón en la pieza de sujeción y apretar los tornillos de seguridad.  
Apretar el tensor del cable situado en el florón.

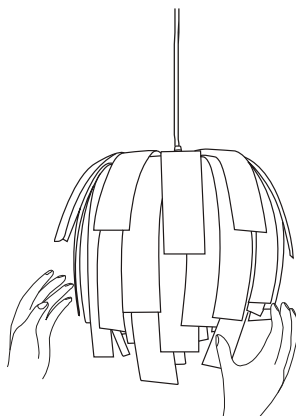

## 3

The lamp should be treated carefully. Occasionally holding of the lampshade with strength may modify its original desing. To solve it, open the lampshade and mold with your hands all the crushed parts so that they rever their original shape.

En touchant et manipulant l'abat-jour il est possible de le déformer. Dans ce cas, ouvrez l'abat-jour et placer votre main sur toutes les parties froissées afin qu'elles retrouvent leur forme originale.

Debido a la flexibilidad del material, al manejar la tulipa se puede modificar su diseño original. Para solucionarlo, moldear con la mano las zonas dónde se aplaste para que vuelvan a su posición original.