

Kite

ref. **KT06G**

Wall sconce & ceiling flush mount

SIMETECH® by arturo alvarez

**BEST OF
YEAR 2014**

Innovative translucent shading
lighting solution

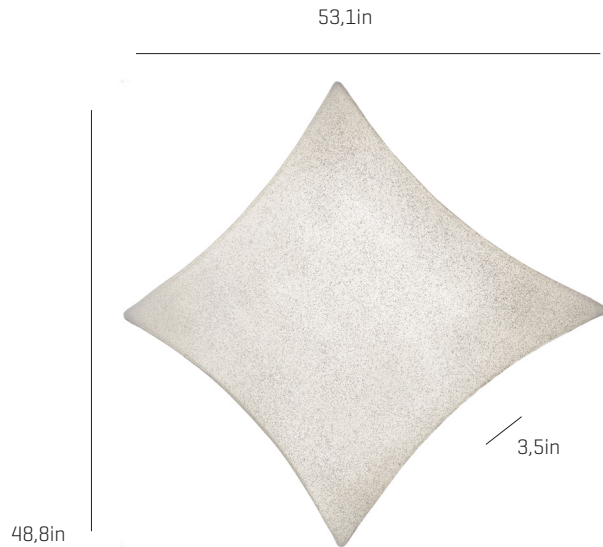

Kite Collection

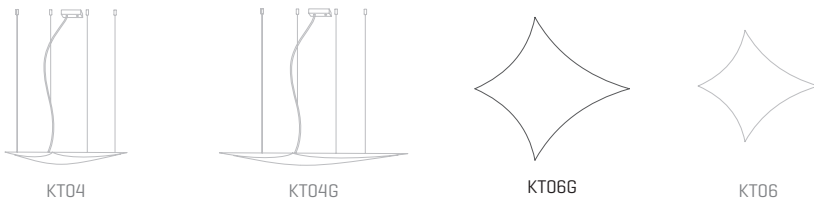

MATERIAL FINISHES

LAMPSHADE

SIMETECH® by arturo alvarez

One color to choose



SUPPORT

Stainless steel

MOUNTING OPTIONS

Wall sconce & Ceiling flush mount

RECOMMENDED BULBS

120V - 60Hz

➡ T5 HO Bi-pin - 4x24 W

OTHER TECHNICAL DATA

NET WEIGHT

15,9lb

PACKAGING

40,1x40,1x4,7in

22lb

ELECTRICAL FEATURES



CERTIFICATIONS



Box contains | Contenido de la caja:

- A** - Lampshade | Tulipa [1]
- B** - Frame | Soporte [1]
- C** - Screws | Tornillos [4]
- D** - Wall Plugs | Tacos [4]

E - Electrical disposal | Ficha [3]

ref. **KT06G**

Suitable for indoor use, at 77°F

Apta para uso interior a temperatura ambiente de 77°F

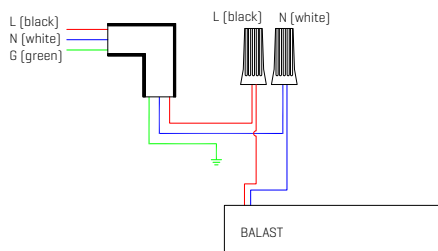
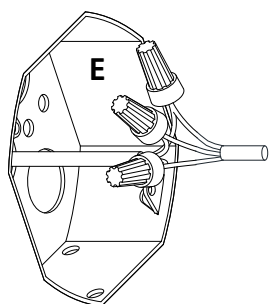

1

Pass the electric cables to the interior and do the electric connection inside the octagon box, please follow the instructions.

Pasar los cables eléctricos al interior y hacer la conexión eléctrica dentro de la caja de conexiones, siguiendo las instrucciones.

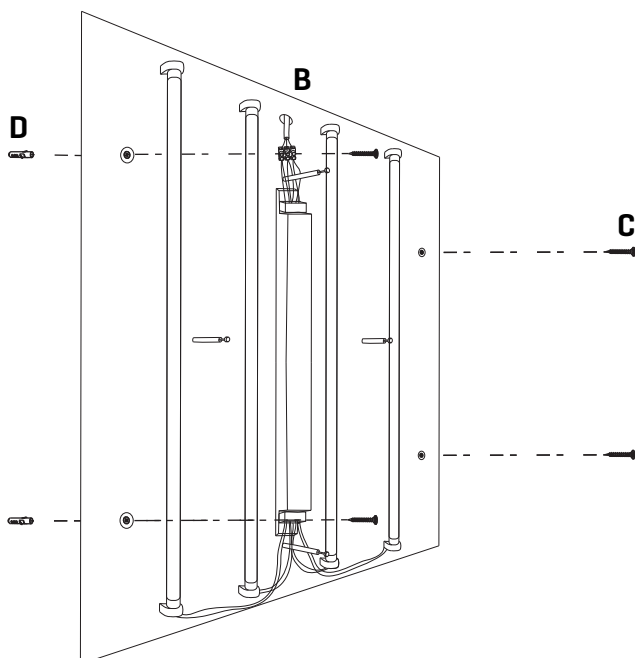

2

In order to properly fix the support, put the horizontal line according to the sketch: be sure that the label is on the right (see drawing). Drill the holes into the wall, fit the wall plugs into the holes and screw the support. Make the electric connection inside the electrical disposal.

Para la correcta colocación del soporte, mantener la línea horizontal en la posición del dibujo, asegurándose de que la etiqueta queda a su derecha [ver dibujo]. Realizar los agujeros en la pared, colocar los tacos y atornillar el soporte. A continuación hacer la conexión eléctrica dentro de la ficha.

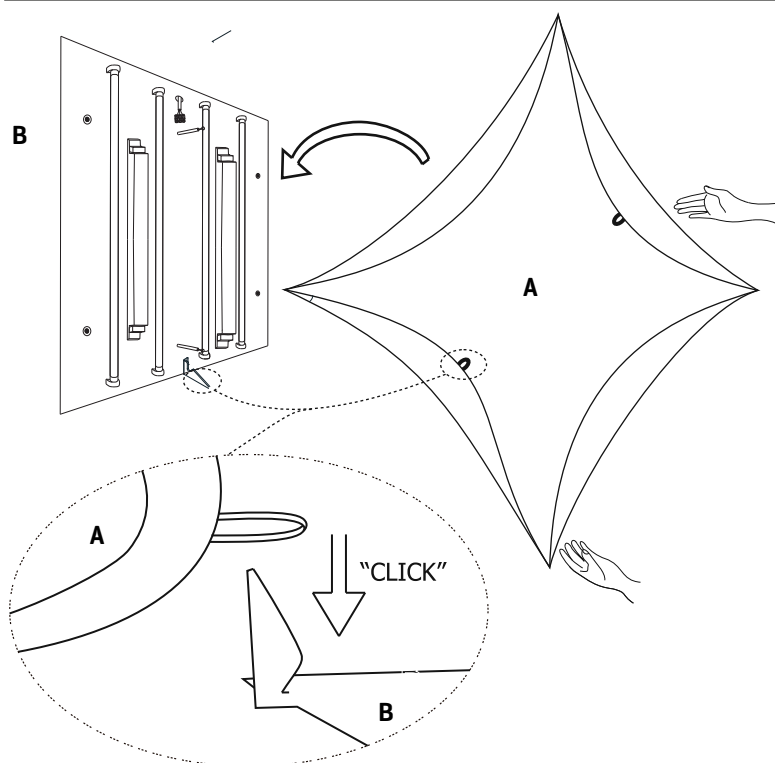

3

Fit the bulbs into the holders and fix the lampshade to the support by fitting together the lobe [e.g.,hook] and the coupling in the lampshade.

Colocar las bombillas en los portalámparas y posicionar las tulipa sobre el soporte, encajando los salientes del soporte en los enganches de la tulipa.

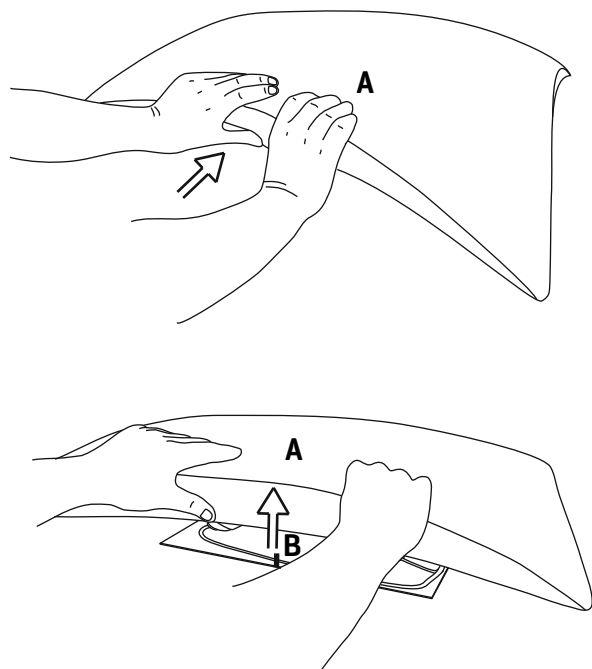

4

To pull the lampshade out, please thrust into the middle and then upwards (in both two coupling areas).

Para sacar la tulipa del soporte, empujar hacia el centro y luego hacia arriba [en las dos zonas de enganche].