

a

emotional light

curvas collection

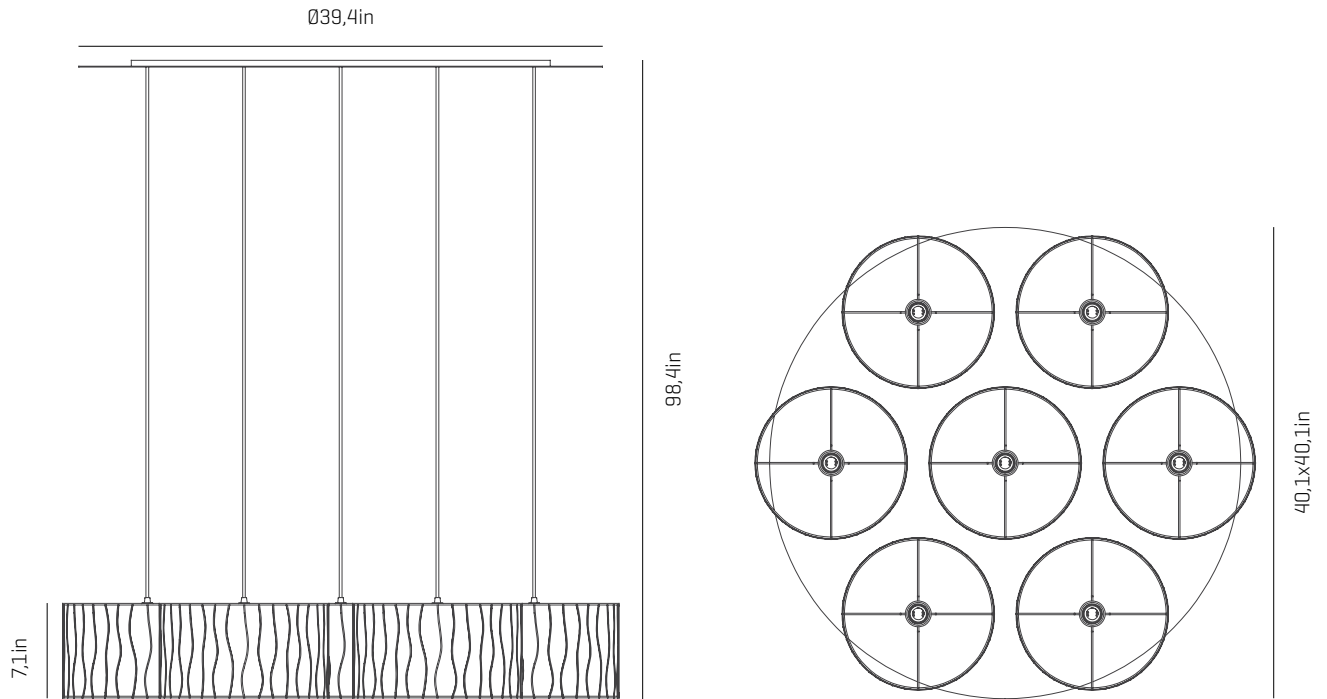

USA & Canada

ref. CV04-7

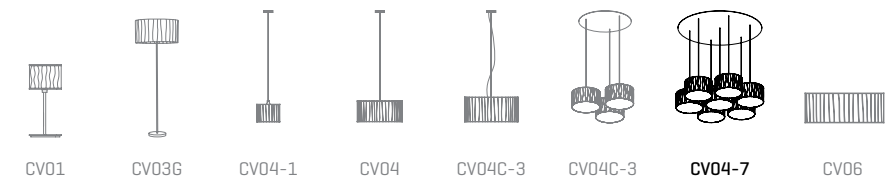

MATERIALS & COMPONENTS

LAMPSHADE

Glass | One color to choose

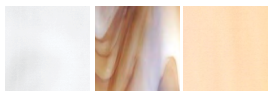

02 95 87

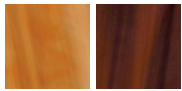

89 90

Bottom diffuser

ref. 7xCV04

CANOPY AND CABLE

DIBOND®

Transparent or black cable

Length customizable

RECOMMENDED BULBS

120V - 60Hz

 E26 LED- Max. 7x12 W

OTHER DATA

NET WEIGHT

39,7lb

PACKAGING

31,5x 47,2x 49,2in

77lb

ELECTRICAL FEATURES



CERTIFICATIONS



emotional light

Curvas

ref. CV04 - 7

Suitable for indoor use, at 77°F
Convient pour une utilisation en intérieur à une température ambiante de 77°F
Apta para uso interior a temperatura ambiente de 77°F

Box contains
Contenu de la boîte | Contenido de la caja:

- A** - Lampshade
Abat jour | Tulipas [7]
- B** - Canopy
Rosace | Florón [1]
- C** - Frame
Support | Soporte [1]
- D** - Cap
Capuchon | Tapón [3]
- E** - Screws
Vis | Tornillos [4]
- F** - Wall plug
Cheville | Tacos [4]
- G** - Electrical disposal
Domino électrique | Ficha conexión [3]

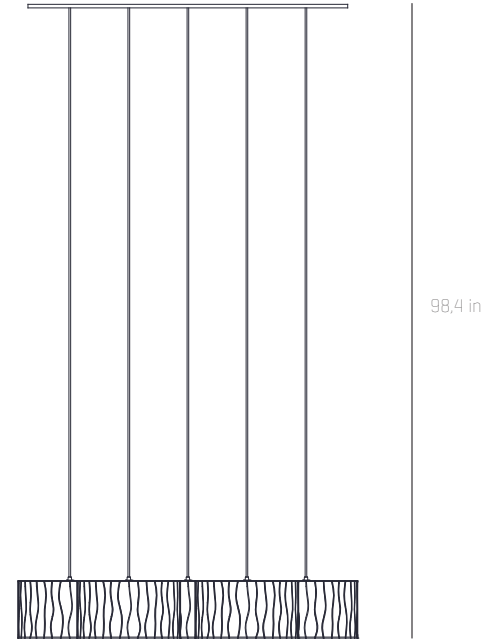
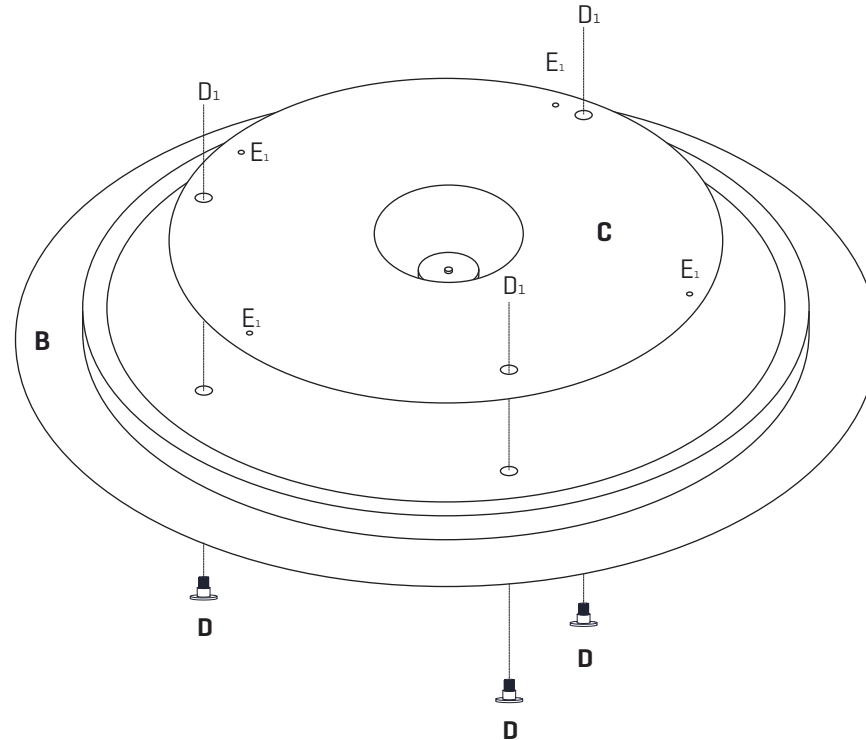

FRONTAL VIEW | VUE DE FACE | VISTA FRONTAL

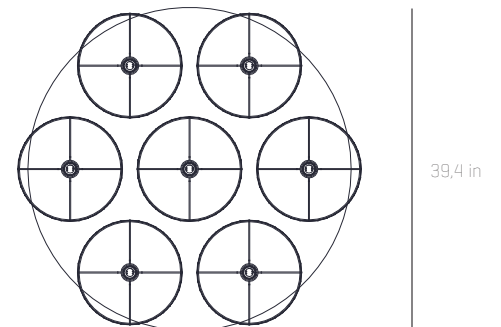

BOTTOM VIEW | VUE DE DESSUS | VISTA INFERIOR
POSITION LAMPSHADES | POSITION D'ABAT JOUR | POSICIÓN DE LAS TULIPAS

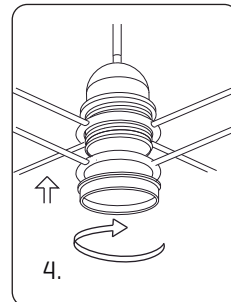
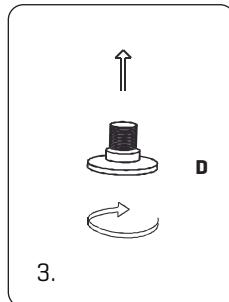
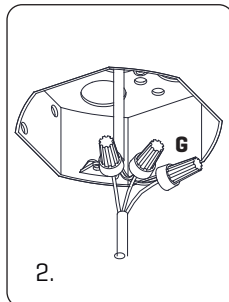
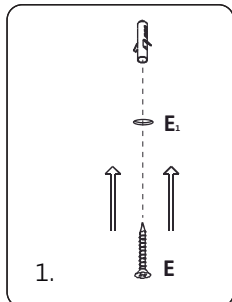

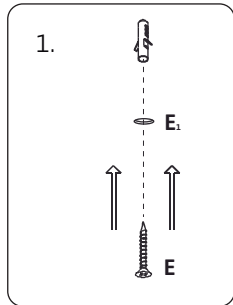

1. Make holes in the ceiling as marked in the frame with the letter E₁, insert the wall plugs and fix the frame.
* Our plugs are appropriate for concrete ceilings only

1. Faites des trous dans le plafond comme indiqué dans le cadre avec la lettre E₁, insérez les chevilles et fixez le cadre.
* Nos chevilles sont appropriées pour les plafonds en béton seulement

1. Hacer los taladros en el techo según los marcados en el soporte con la letra E₁, colocar los tacos y fijar el soporte.
* Nuestros tacos son sólo aptos para superficies de hormigón

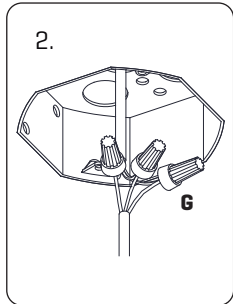

2. Pass the electrical wires inside the octagon box.
Make the electrical connections taking care to respect the correct polarity as the color code.

2. Passez les câbles électriques à l'intérieur de la boîte octogonale.
Faites les connexions électriques en prenant soin de respecter la polarité correcte avec le bon code couleur.

2. Pasar los cables eléctricos al interior de la caja de conexiones.
Realizar la conexión eléctrica en las fichas de conexión G teniendo cuidado de respetar la polaridad correcta según el código de colores.

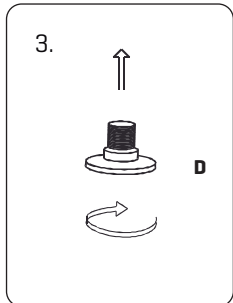

3. Once the frame is fixed, screw the caps in the holes marked with D.

3. Une fois le cadre fixé, vissez les capuchons dans les trous marqués d'un D.

3. Colocado el soporte, enroscar los tapones en los taladros marcados con la letra D.

4. To access the inside of the luminaire and to install the bulbs, remove the lower diffuser tilting it.

4. Pour accéder à l'intérieur du luminaire et placer l'ampoule retirer le diffuseur inférieur en l'inclinant

4. Para acceder al interior de la luminaria y colocar la bombilla quitar el difusor inferior inclinándolo.

