

a

emotional light

ura collection

LED

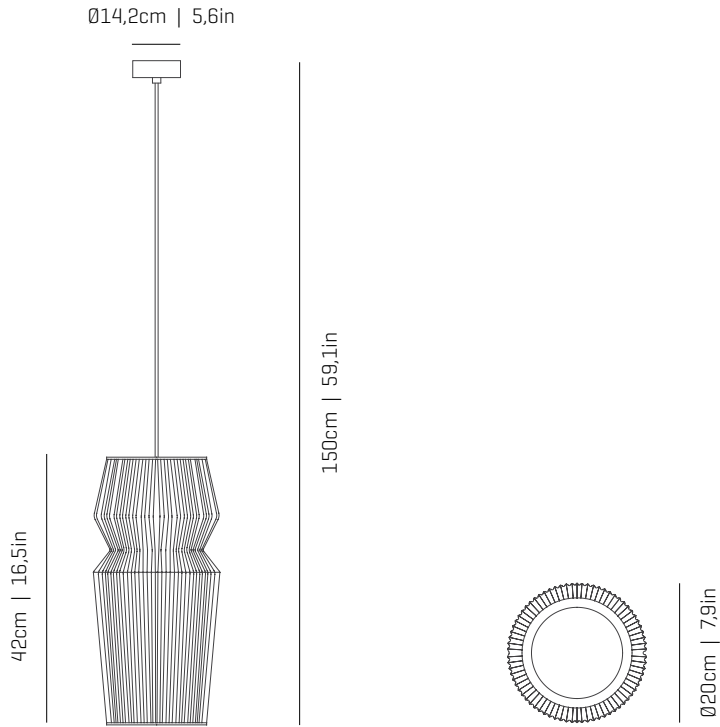

ref. UR204-LD



MATERIALS & COMPONENTS | MATERIALES & COMPONENTES

LAMP SHADE | TULIPA

Painted stainless steel | One color to choose
Acero inoxidable pintado | Un color a elegir



BL

BE

G

T

CUSTOM
COLOR

Stainless steel Acero inoxidable

Bottom diffuser Difusor inferior

CANOPY AND CABLE

FLORÓN Y CABLE

Steel gloss nickel-plated
Acero níquel-satinado

Transparent or black cable
Cable transparente o negro

Standard: 150cm | 59,1in
Length/largo customizable
120V: 200cm | 78,7in

LIGHT SOURCE BUILT IN

FUENTE DE LUZ INCLUIDA

230V - 50Hz

17W 2700K 1645lm built-in
upon request 3000K 1776lm

Dimming system: PHASE CUT
upon request DALI / Switch DIM

100~277V - 60Hz

17W 2700K 1645lm built-in
upon request 3000K 1776lm

Dimming system: PHASE CONTROL & 0-10V
(only 120Vac TRIAC Dimmers)

ENERGY EFFICIENCY

EFICIENCIA ENERGÉTICA

This product contains a light source of energy efficiency class D
Este producto contiene una fuente luminosa de la clase de eficiencia energética D

OTHER DATA | OTROS DATOS

NET WEIGHT | PESO NETO

1,7kg | 3,7lb

PACKAGING | EMBALAJE

46x24x25cm | 18,1x 9,4x 9,8in
2,1kg | 4,6lb

ELECTRICAL FEATURES

CARACTERÍSTICAS ELÉCTRICAS



CERTIFICATIONS

CERTIFICACIONES



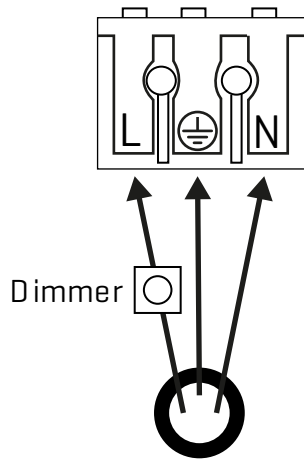

3

This luminaire includes the regulating system by the phase cut, for the power of the reduction of luminous flux, carries out the connection in the manner indicated in this step.

Esta luminaria incluye sistema de regulación por corte de fase, para poder obtener una reducción del flujo luminoso, realice el conexionado de la manera indicada en este paso.

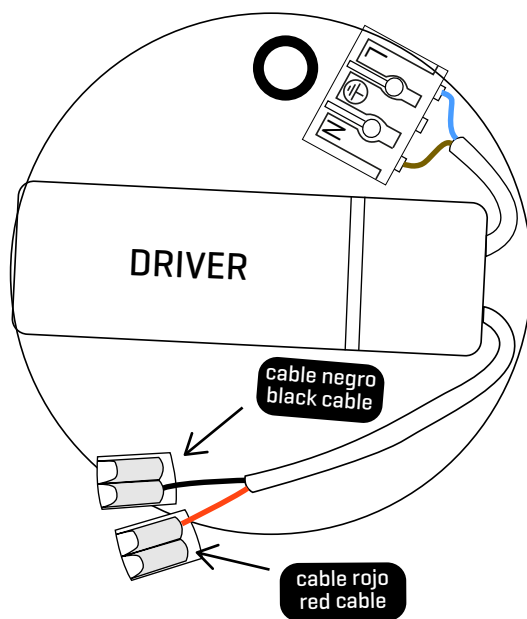

4

LED CONNECTION:

Once the light source is connected, proceed to connect the luminaire to the connection tabs, respecting the color code for low voltage:

RED WITH RED - POSITIVE

BLACK WITH BLACK - NEGATIVE

To do this, lift the free orange label and insert the cable marked with the base corresponding to the color you are connecting.

CONEXIÓN LED (luminaria):

Una vez tenga conectada la fuente de luz, proceda a conectar la luminaria a las fichas de conexión respetando el código de colores para baja tensión:

ROJO CON ROJO - POSITIVO

NEGRO CON NEGRO - NEGATIVO

Para ello levante la pestaña naranja libre e introduzca el cable marcado con la funda correspondiente al color que esté conectando.

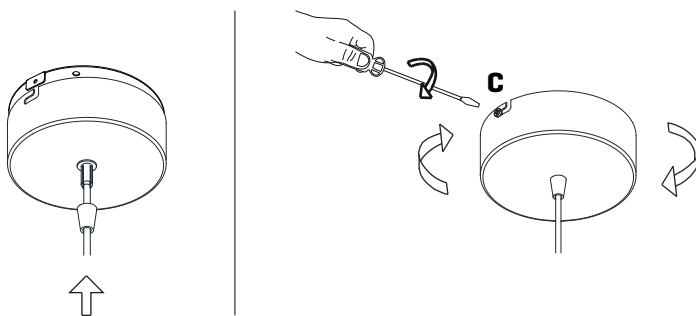

5

Insert the canopy in the holding piece and tight the security screws.

Tighten the strain relief situated on the canopy

Encajar el florón en la pieza de sujeción y apretar los tornillos de seguridad.

Apretar el tensor del cable situado en el florón.

Ura 2

ref. UR204-LD

Suitable for indoor use, at 25°C

Apta para uso interior a temperatura ambiente de 25°C

Box contains | Contenido de la caja:

- | | |
|---|--|
| A - Lampshade Tulipa [1] | E - Electrical disposal Ficha [1] |
| B - Holding piece Pieza de sujeción [1] | F - Screws Tornillos [2] |
| C - Lampholder Portalámparas [1] | G - Canopy Florón [1] |
| D - Security screws Tornillos de seguridad [2] | H - Wall Plugs Tacos [2] |



LED

SAFETY NOTE: Switch off mains supply before commencing installation

Light source not user replaceable: The light source of this light must be replaced by the manufacturer, its service or equivalent qualified person.

INDICACIÓN DE SEGURIDAD: Desconecte la alimentación eléctrica antes de empezar con la instalación.

Fuente de luz no reemplazables por el usuario: La fuente de luz de esta luminaria debe reemplazarse por el fabricante, servicio técnico o persona cualificada equivalente.

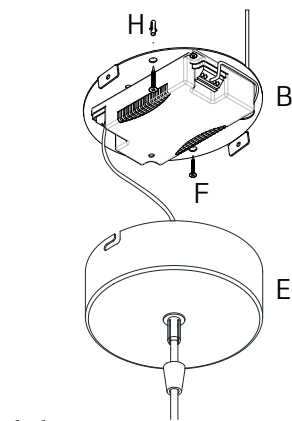

1.1

See the circuit diagram
on the back of this sheet

Ver diagrama de circuito en el
reverso del folio

1.2

1

1.1 Drill the holes in the ceiling, fit the wall plugs into them and screw the holding piece.
1.2 Do the electric connection, please follow the instructions.

1.1 Realizar los agujeros en el techo, colocar los tacos y atornillar la pieza de sujeción.
1.2 Hacer la conexión eléctrica siguiendo las instrucciones.

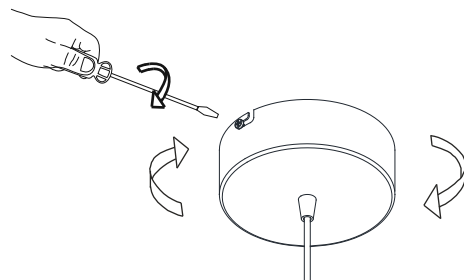
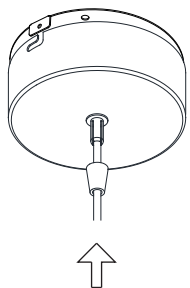

2

Insert the canopy in the holding piece and tight the security screws.
Tighten the strain relief situated on the canopy

Encajar el florón en la pieza de sujeción y apretar los tornillos de seguridad.
Apretar el tensor del cable situado en el florón.

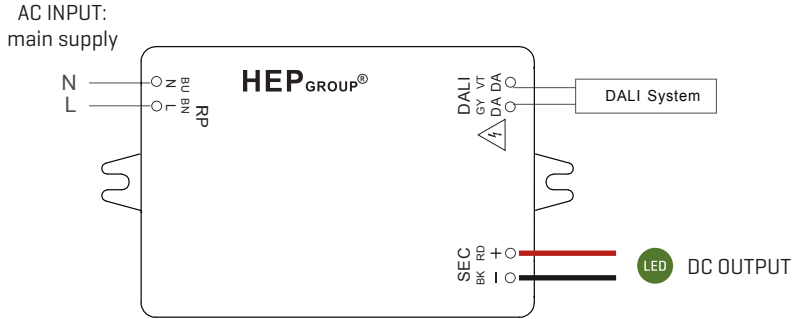

Circuit diagram DALI

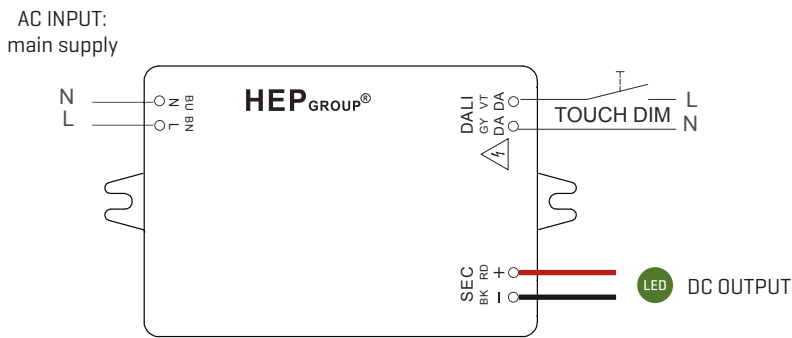

Circuit diagram TOUCH DIM

Touch Dim

Short push (< 0.6 sec)
Long push (> 0.6 sec)

Push to turn ON-OFF
Dimming up or down

Synchronization of a large number of driver of Touch Dim

- | | | |
|----------|------------|---|
| 1. Step: | Long push | All the lamps are switched on |
| 2. Step: | Short push | All the lamps are switched off |
| 3. Step: | Long push | All the lamps are switched on the minimum dimming setting of the drivers and continuously |

Fade up to the desired dimming level, then release push button.

Max. 15pcs parallel units

AC INPUT: main supply		DC OUTPUT: LED		Dimming control	
N	L	-	+	-	+
blue	brown	black	red	grey	purple