

a

emotional light

lea collection

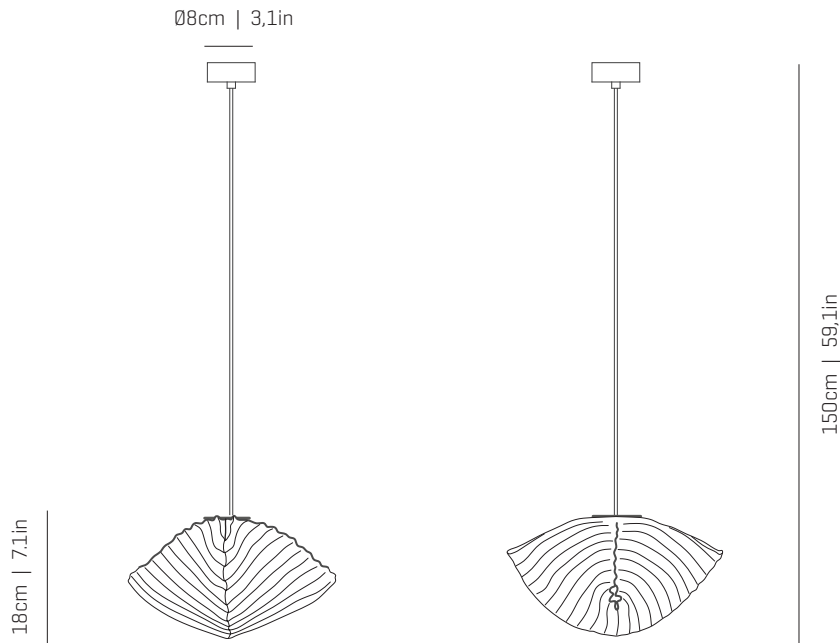

ref. LA04-Mini

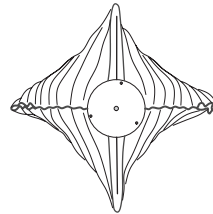

Approximate measurements
Medidas aproximadas

MATERIALS & COMPONENTS | MATERIALES & COMPONENTES

LAMPSHADE | TULIPA

Painted stainless steel | One color to choose
Acero inoxidable pintado | Un color a elegir

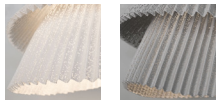

BL

G

CUSTOM
COLOR

Stainless steel | Acero inoxidable

CANOPY AND CABLE

FLORÓN Y CABLE

Steel gloss nickel-plated
Acero níquel-satinado



Transparent or black cable
Cable transparente o negro

Standard: 150cm | 59.1in
Length/largo customizable
120V: 200cm | 78.7in

RECOMMENDED BULBS

BOMBILLAS RECOMENDADAS

230V - 50Hz

-  E14 LED Vintage - Max. 1x12 W
-  E14 LED Standard - Max. 1x12 W

120V - 60Hz

-  E12 LED - Max. 1x12 W

OTHER DATA | OTROS DATOS

NET WEIGHT

PESO NETO

0,8kg | 1,8lb

PACKAGING

EMBALAJE

36x36x31cm | 14.2x14.2x12.2 in
1,2kg | 2,3lb

ELECTRICAL FEATURES

CARACTERÍSTICAS ELÉCTRICAS



CERTIFICATIONS

CERTIFICACIONES



Lea

ref. LA04-Mini

Suitable for indoor use, at 25°C

Apta para uso interior a temperatura ambiente de 25°C

Box contains | Contenido de la caja:

A - Lampshade | Tulipa [1]

B - Holding piece | Pieza de sujeción [1]

C - Lampholder | Portalámparas [1]

D - Security screws | Tornillos de seguridad [2]

E - Electrical disposal | Ficha [1]

F - Screws | Tornillos [2]

G - Canopy | Florón [1]

H - Wall Plugs | Tacos [2]



ATTENTION! The canopy is subject to one if the covers the box
ATENCIÓN! El florón va sujeto a una de las tapas de la caja.

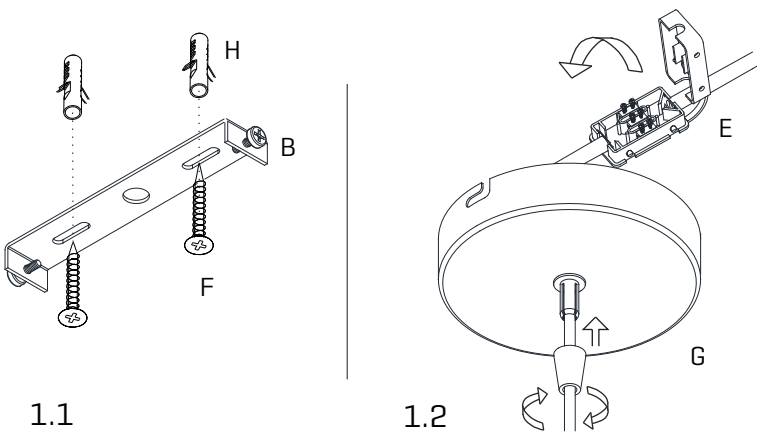

1

1.1 Drill the holes in the ceiling, fit the wall plugs into them and screw the holding piece.
1.2 Pass the electric cables to the interior and do the electric connection, please follow the instructions.

1.1 Realizar los agujeros en el techo, colocar los tacos y atornillar la pieza de sujeción.
1.2 Pasar los cables eléctricos al interior y hacer la conexión eléctrica dentro de la caja de conexiones, siguiendo las instrucciones.

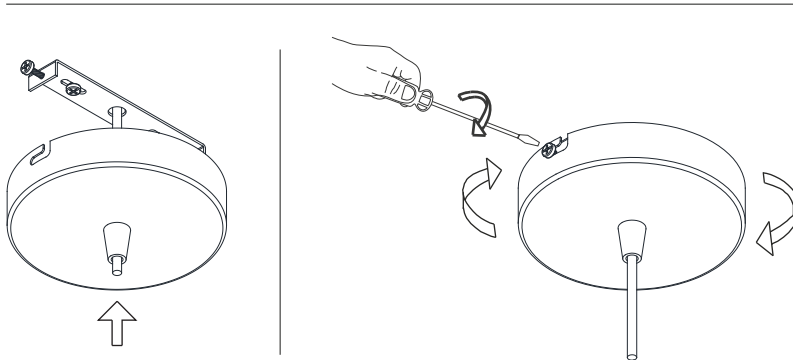

2

Insert the canopy in the holding piece and tight the security screws.
Tighten the strain relief situated on the canopy.

Encajar el florón en la pieza de sujeción y apretar los tornillos de seguridad.
Apretar el tensor del cable situado en el florón.

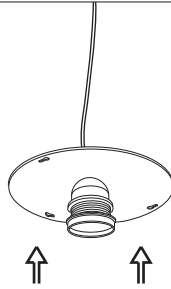
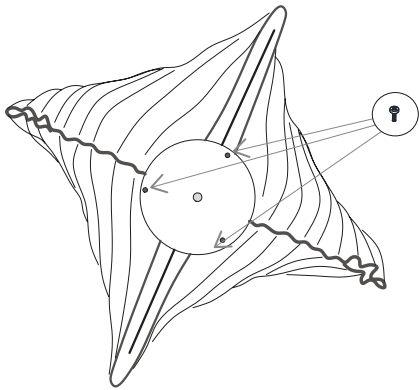

3

Loosen the 3 screws that connect the lampshade to the electric support (it is not necessary to remove them completely) and turn the support to separate it from the lampshade.

Afloje los 3 tornillos que unen la tulipa con el soporte eléctrico (no es necesario quitarlos completamente) y gire el soporte para poder separarla de la tulipa.

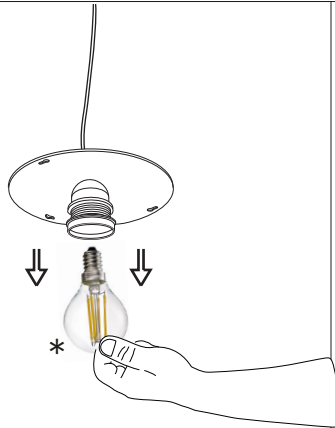
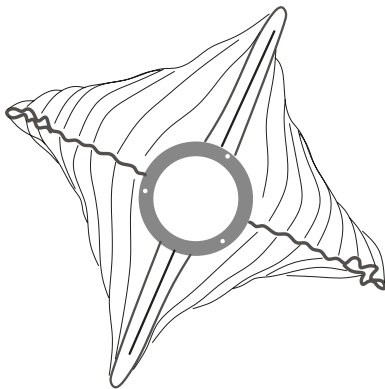

4

Once you have the support separated from the lampshade, you can place the chosen bulb. Repeat the process in reverse, fitting the lampshade into the slots of the support and turning until it stops. Tighten the hooking bolts to secure the assembly.

NOTE: The screen must not be in contact with the bulbs.

Una vez tenga el soporte separado de la tulipa puede colocar la bombilla elegida. Repetir el proceso a la inversa, encajando la tulipa en las rendijas del soporte y girando hasta que haga tope. Apretar los tornillos de enganche para asegurar el conjunto.

NOTA: La malla no debe estar en contacto con las bombillas.

*E14 Bulb