

## Vento

ref. VN04-1

Pendant lamp

Lámpara colgante

[Click here to download:](#)

3D/2D, pictures, photometric curves  
and assembly instructions

[Clica aquí para descargar:](#)

3D/2D, fotografías, curvas fotométricas  
e instrucciones de montaje

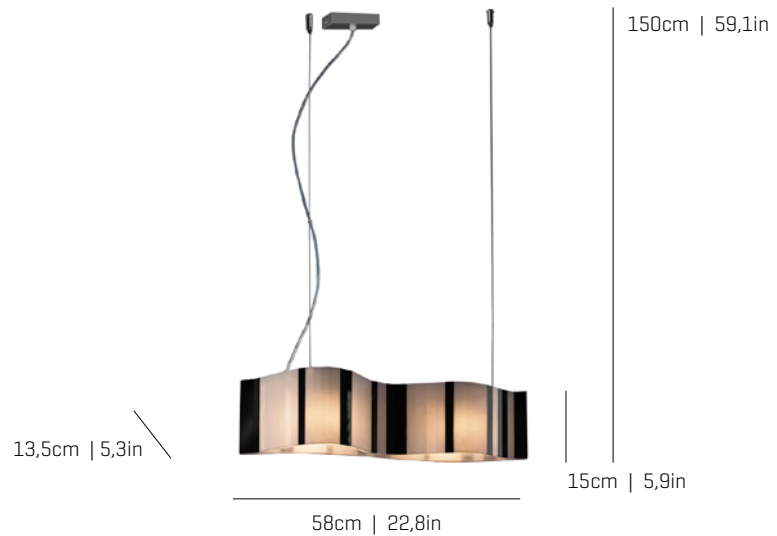

Vento Collection



VN01



VN02



VN04-LD



VN04-1



VN06

### MATERIAL FINISHES MATERIALES Y ACABADOS

#### LAMPSHADE TULIPA

Glass Vidrio

One color to choose Un color a elegir

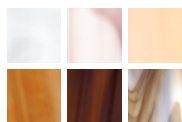

Color combinations

Pink Rosa Brown Marrón



#### CANOPY AND CABLE FLORÓN Y CABLE

Stainless steel

Acero inoxidable

Black or transparent

Cable negro o transparente

### LIGHT SOURCE FUENTE DE LUZ

#### 230V - 50Hz

G9 LED - Max. 2x4 W

G9 ECO - Max. 2x42 W

G9 - Max. 2x33 W

#### 120V - 60Hz

G9 Bi-pin - Max. 2x40 W

#### ENERGY EFFICIENCY EFICIENCIA ENERGÉTICA

from A+ to C  
desde A+ a C

### OTHER TECHNICAL DATA OTROS DATOS TÉCNICOS

#### PACKAGING EMBALAJE

80x30x30cm | 31,5x11,8x11,8in

3,7kg | 8,2lb

#### ELECTRICAL FEATURES CARACTERÍSTICAS ELÉCTRICAS



#### CERTIFICATIONS CERTIFICACIONES



Box contains | Contenido de la caja:

- |   |                                  |
|---|----------------------------------|
| A - Whole set piece   Pieza de conexión [1] | E - Tie rod   Tensor [2]         |
| B - Canopy   Florón [1]                     | F - Wire connectors   Fichas [3] |
| C - Wall plugs   Tacos [2]                  | G - Lamphshade   Tulipa [1]      |
| D - Screws   Tornillo [2]                   |                                  |

ref. **VN04-1**

Suitable for indoor use, at 25°C

Apta para uso interior a temperatura ambiente de 25°C

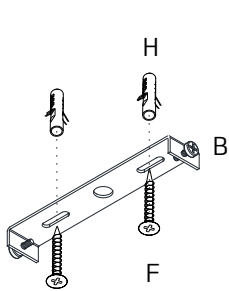

1.1

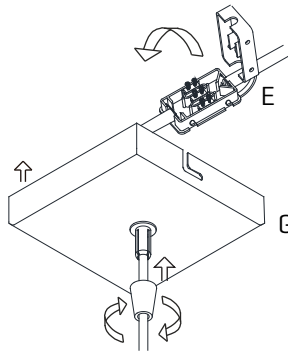

1.2

## 1

1.1 Drill the holes in the ceiling, fit the wall plugs into them and screw the holding piece.  
1.2 Pass the electric cables to the interior and do the electric connection, please follow the instructions.

1.1 Realizar los agujeros en el techo, colocar los tacos y atornillar la pieza de sujeción.  
1.2 Pasar los cables eléctricos al interior y hacer la conexión eléctrica dentro de la caja de conexiones, siguiendo las instrucciones.

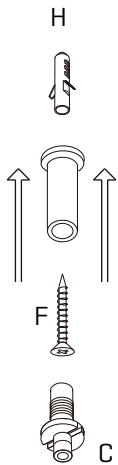

2.1

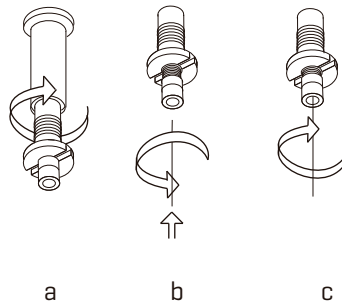

2.2

## 2

2.1. Drill the holes, fit the wall plugs into them and fix the metallic frame to the ceiling.  
2.2. a) Screw the tie rod. b) Loosen the security nut and introduce the steel wire. c) Tighten the security nut. In order to remove the cable from the tension loosen the nut, to push it upwards and to throw of the cable.

2.1. Hacer los agujeros, colocar los tacos y fijar la pieza metálica al techo.  
2.2. a) Enroscar el tensor. b) Aflojar la tuerca de seguridad e introducir el cable de acero. c) Apretar la tuerca de seguridad. Para sacar el cable del tensor aflojar la tuerca, empujarla hacia arriba y tirar del cable.

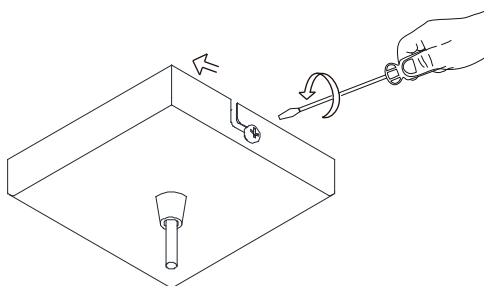

## 3

Insert the canopy in the holding piece and tight the security screws. Tighten the strain relief situated on the canopy.

Encajar el florón en la pieza de sujeción y apretar los tornillos de seguridad. Apretar el tensor del cable situado en el florón.